

ACO, FCO, PCO, WBT
Wall Brackets

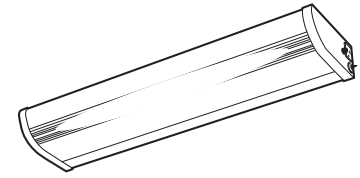

CATALOG NUMBER _____
 TYPE _____
 DATE _____
 PREPARED BY _____
 PROJECT _____

HOUSING: Die-formed heavy gauge steel with high-gloss baked white enamel finish over rust inhibiting phosphate coat. Steel faux chrome and brass finished ends.

SHIELDING: Wraparound, translucent milk white smooth acrylic diffuser.

ELECTRICAL: Fluorescent wired for 120V, 60Hz AC operation, thermally protected, Class P, sound rated A, energy saving ballast, unless otherwise specified. Magnetic T12 shall be high power factor. Electronic T8 shall be high power factor, instant start, <20% harmonic distortion standard, specify suffix UNV for <10% harmonic distortion. Residential Electronic T8 shall be low power factor, Class B for EMI and RFI. Specify suffix UNV for universal voltage, 120 through 277V, 50/60Hz AC operation, Electronic T8 only. UL and C-UL listed, damp location.

MOUNTING: Wall mount.

Wall Brackets Ordering Information

Series	# Lamps	Lamp Type	Ends
ACO	1	15 = 15W 18" T8	Leave blank for chrome
FCO	2	17 = 17W 24" T8	WE = White ends
PCO*		20 = 20W 24" T12	
WBT		25 = 25W 36" T8	
		30 = 30W 36" T12	
		32 = 32W 48" T8	
		40 = 34/40W 48" T12	

*PCO fixtures are available with 1-lamp only

Ballast	Voltage	Options
B11 = Electronic T8	UNV = 120-277V*	Push Switch and Outlet (Standard)
B22 = LPF T8/T12 120V	120 = 120V	CO = Convenience Outlet only
		SW = Switch only
		LA = Less switch and outlet

*UNV only available when unit is less outlet and switch

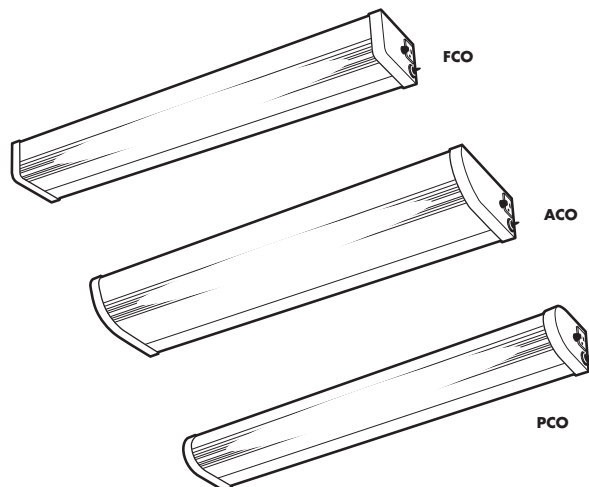

Dimensions

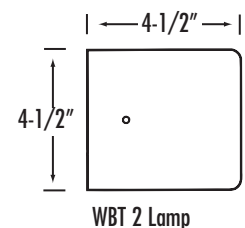
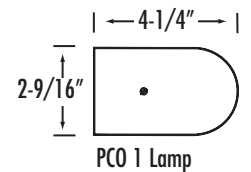
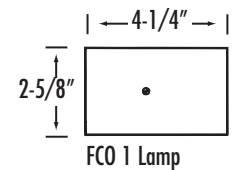
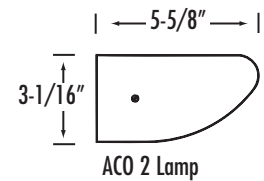
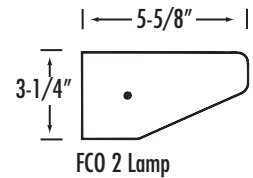

ACO, FCO (2 Lamp), PCO and WBT lengths are 18-1/4", 24-1/4", 36-1/4" and 48-1/4". FCO 1 lamp lengths are 18-3/8", 24-3/8" and 48-3/8".